

KIT50LISSE / SMOOTH COLUMN (KIT 50CM)

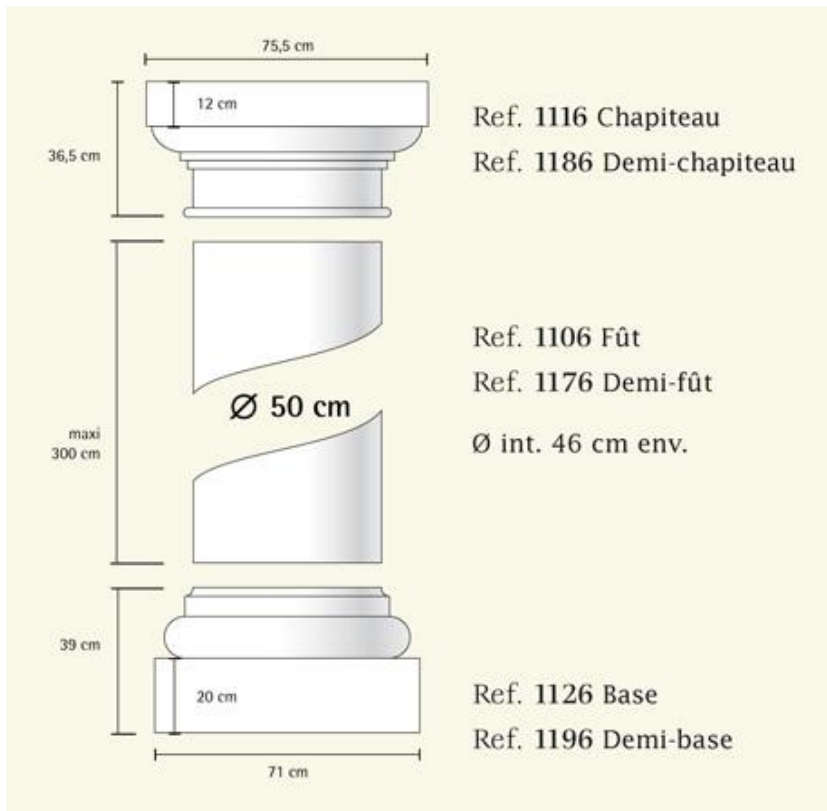

10cm diameter column and half-column.

Consist of one base (or half base), one shaft (or half shaft) and one capital (or half capital).

Half-columns may be used alone as decoration against a wall, or two by two to dress a pillar.

Discover the whole Kit Columns collection

